

User Manual

CE-6000A EV Battery Test System



Attention

PLEASE:

- **Read the User Manual before operating**
- **Preserve the User Manual.**
- **Read carefully for safety matters.**

Manufacturer: NEWARE TECHNOLOGY LLC

www.neware-usa.com
www.neware-euro.com
www.neware-uk.com
www.neware-asia.com
www.neware-japan.com
www.neware-korea.com
www.neware-china.com
www.neware.com.cn
www.neware-store.com

Catalog

Welcome	2
Installation	4
Chapter 1. Inspection	5
Chapter 2. Installation	5
2.1 Appearance	5
2.2 Installation of Cabinet	6
2.3 Electric connection	8
2.4 Installation Tools	13
Operation	14
Chapter 3. Safety Notice	15
3.1 Safety Precautions	15
3.2 Operating requirements for technician	15
3.3 Label Requirements	16
3.4 Safety Warning Requirements	16
3.5 Fire Escape Requirements	16
3.6 Installation Requirements	16
3.7 Electrical Connection Requirements	16
3.8 Power-off Operation Requirements	17
3.9 Scrap Requirements	17
3.10 Other Protection Requirements	18
Chapter 4 .Equipment Introduction	18
4.1 System Composition	18
4.2 System Topology	19
4.3 Specification	20
Chapter 5 .Touch Screen Description	24
5.1 Home page	24
5.2 Overview	25
5.3 Setting	26
5.4 Switch machine	27
5.5 Operating data	28
5.6 Fault record	28
5.7 Automatic calibration	29
Chapter 6.Operation	31
6.1 Power on	31
6.2 Power off	31
Chapter 7. Maintenance	32
7.1 Relevant matters	32
7.2 Inspection and maintenance	32
7.3 Clean Maintenance	33
Chapter 8 .Repairing	33
8.1 Recovering of fault operation	33
8.2 Common faults	33
Chapter 9 .Warranty	35

Welcome

Thank you for choosing Neware. We offer quality production and reliable after-sales service to you.

To ensure the safe operation and the functionality of the equipment, please read this user Manual carefully before operation.

This manual will introduce the fundamental theory, standard, construction, norms of operation, maintenance, trouble-shooting for potential faults, and electrical diagram. Any "test regulation" standards that were mentioned in this menu were for reference only. If you have any objections, please consult the relevant standard-document or research materials.

This manual is intended to instruct the user to properly operate the equipment. Please read carefully.

Liabilities

Neware is not responsible for the damage that results from negligence or fault operations that are not caused by Neware. Please follow this "user manual" to avoid potential negligence or fault.

Attention

Keep the manual.

Ask for a replacement if any errors in this manual are found.



Constitute:

This manual is consisted from 4 parts for potential needs.

Name	Content
Welcome	The description of this manual and the general description of the equipment.
Installation	Related installation operations include solutions for installation, setup, and moving.
Operation	Introduction to the equipment's fundamental operation methods, and related troubleshooting for problems that you might encounter.
Reference	Relevant references to this equipment.

Statement of Safety Symbols:

The symbols below will be indicated in this manual.

 Danger	A faulty operation can result in serious harm. Do not operate the equipment under this condition.
 Warning	A faulty operation can result in a minor injury. Additionally, equipment or test samples will be damaged.
 Attention	Utility or damage prevention indicator.

Keywords:

Steps: operation command

Reference: information for reference

Description of test equipment's relevant information:

The naming of this equipment is based on the series, the quantity of the channels, the level of voltage/current, the type of charge/discharge port, and the optional negative voltage.

Please check the nameplate on the equipment to confirm the model type.

This manual will include all the models of CE-6000 series equipment. You will be only responsible for reading about the specific model that you purchased.

Model	CE-60XXA	-	5V	300A	-H
Sign	①		②	③	④
Means	①	EV battery Test System, XX stands for quantity of channels (e.g. CE-6002A stands for two channels, CE-6012A stands for 12 channels).			
	②	Output voltage for each channel			
	③	Output current for each channel			
	④	-B: separated charge and discharge ports -H: 100Hz recording frequency (Hint: 10Hz recording frequency came without ④)			

Installation

CE-6000A EV Battery Test System



Attention

- **This chapter introduces how to install the tester.**
- **Read this chapter if you need to re-install the equipment.**
- **Users must read this chapter no matter whoever is responsible for installation.**

Chapter 1. Inspection

Check the items according to the "Packing List" and confirm that all the required items were sent.

If you have any special ordered spare, please check the "Packing List" to confirm.

Contact the supplier (Neware) if there is any loss or damage.

Notice: A "Packing List" will be shipped with the equipment.

Chapter 2. Installation

This chapter introduces the appearance of the equipment and the required conditions for installation.

2.1 Appearance



Cabinet(For reference only)

NO.	Name	Functions / Usage
1	Warning lamp	Display working conditions
2	Screen	Man-computer interaction interface
3	Stop button	Emergency protection
4	Indicator	Operation indicator
5	Equipment power cord holder	Equipment power cord cross it for connection
6	Footing	For equipment positioning
7	Caster	For short distance moving
8	Breaker	On/Off switch of power supply
9	Net port	Network communication port
10	Output channel cable	Channel cable for batteries connection
11	Battery voltage sampling port	Sampling the voltage of the connected battery

2.2 Installation of Cabinet

Site configuration

This part indicates the spatial requirements for the equipment to ensure safe operation.

■ Site requirement for installation

- The equipment is required to be setup on the floor with flame-proof material, and the flooring is constructed with the U-bar. The floor is required to be flat and firm enough to support the weight of the equipment.
- Adequate ventilation and no direct sunlight.
- Temperature: -10°C~40°C, no rapid temperature change.
- Humidity: ≤70% RH(No steam condensation)
- Altitude: <2000
- No high-density dust, no flammable or corrosive components around the equipment.

■ Storage/Operating space

This equipment is designed for in-door usage.

Safety-level-IP20. Equipment is required to be set up on a flat concrete floor or on a setting plate that can support the weight of the equipment. It is suggested to setup an air purification treatment to reduce the effect of the dust.

The air intake is supposed to keep a distance from any closed objects to ensure sufficient ventilation. It is recommended to set up a ventilation device that can control the temperature in the workplace to ensure the long-term reliability of the equipment,

Sufficient space (> 600mm) between testers and walls to ensure ventilation and escape space.

Sufficient space (> 500mm) above the equipment for ventilation, maintenance, and operation.

■ Wire trough requirement

The network cable and power cable should be placed separately to reduce EMI from the power circuit to the network communicator.

■ Moving

This equipment is available for transport by forklift or tray carriage. Check the weight of the equipment and the correct support point for safety purposes.

The forklift is the best transporter for this equipment. The gravity centre of the cabinet is required to be set between the fork arms, and it is suggested to do a test lift. Make sure all the operations are slow and stable. Please place it on the firm and stable floor, and follow the safety operation process.



Warning

Use a forklift with the proper size and elevating capacity to move the equipment. Jack the equipment from the bottom. The cabinet must be secured from slipping when jacking up.

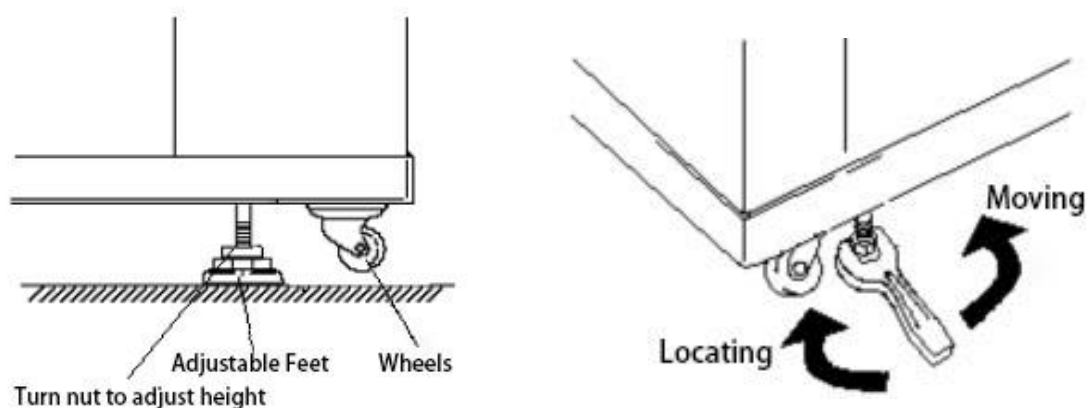

Adjustable feet (optional) are located on each corner at the bottom of the equipment. The height of the adjustable feet is adjusted by tightening or loosening the nut with a wrench. Adjusting the nut in a clockwise direction will lift the wheels off the floor and the equipment will stand firmly on the floor. Adjusting the nut in a counter-clockwise direction will let the wheels connect to the floor, making the equipment moveable.

2.3 Electric connection

Wires for required connections:

- Ground wire
- DC side cable
- AC side cable
- Communication cable

Requirement for Cable

- All the cables required a sufficient current-carrying capability. The current-carrying capability will be affected by the environmental conditions, insulating materials, method of laying, materials of wire, and cross sectional area.
- All the cables must based on the maximum AC current and reserve some retained current.
- All the cables on the same side must have the same parameters and form.
- The cable must be flame-proofed.

CE-6016A-5V300A-H cable recommendation:

Connection cable	Dimension	Mounting hole
Battery side cable	120 mm ² (300A)	M8
AC side cable	16 mm ² (50A)	
Ground cable	10 mm ²	M6

Requirement of power supply

The power supply must meet the below conditions:

- AC Voltage: 380 V±15% , three-phase four-wire + Protective ground wire.
- Frequency: 50/60Hz ±5Hz.
- PGND cable resistance should be less than 4, and a TN-S power supply or TT power supply is required.
- Users are required to set up the air switch or power switch with related capacity, and these switches must independently operate for this equipment.

Grid cable connection

Connect the equipment's cable to the breaker with the method below:

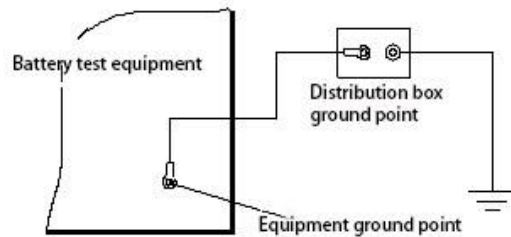
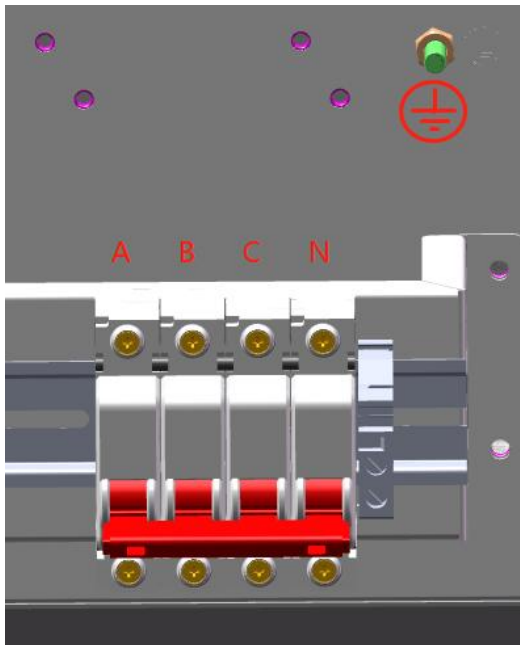

Operation steps

Follow the operation steps below after the equipment is positioned:

1. Make sure all the input switches are fully disconnected, the power sources inside the cabinet are disconnected, and label the **warning** sign on the switch to prevent mistaken operation.
2. Open the covering at the bottom of the back.
3. Connect the grounding wire to the ground screw, as shown in the **PE** sign below.
4. Connect the three-phase AC (A, B, C phase line and neutral line) cable to the breaker.
5. Reinstall the metal covering after all the cables are connected.

Grounding wire

Ground connection will prevent electric shorts or noise generated by abnormal operation. The ground wire is provided. Please prepare the ground wire terminal. The grounding wire terminal connector is on the back of the equipment close to the breaker. Please properly connect the ground wire with the system protection.

The grounding wire should not be less than 2.5mm^2 in diameter and the contact resistance should not be more than 4Ω .

Operation steps:

Refer to Grid cable connection-operation step-3.

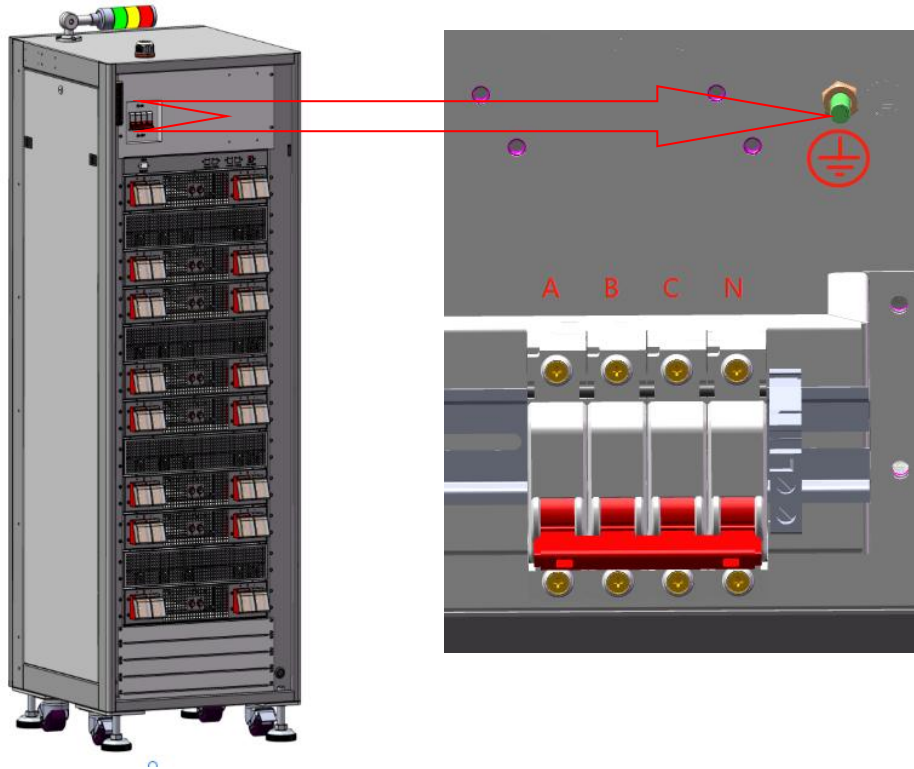

! Danger

- **Explosion!** Do not place the equipment closed to the gas pipe.
- **Grounding is required!** Otherwise, the RCCB will not be functional and cause an electric shock. Also, the power interference protection will be disabled.



Warning

- **Do not use the same grounding terminal as other devices in the absence of an RCCB!** Otherwise, the risk of electric shock will increase.
- **Do not cross-grounding with other devices!** Otherwise, the risk of electric shock will increase.
- **The device's external power sources are not permitted to be paired with power sockets or knife switches.**
- **The power source cable must be tightened with a screw! A loose connection will increase the impedance, generate more heat, and increase the risk of fire.**

Do not turn the power on when:

- Open the cover panel of the electric cabinet.
- Inspecting circuit components or maintaining the equipment.
- **Make sure the voltage of the power source does not exceed $\pm 10\%$ of the nominal voltage. If so, the equipment will generate a caution.**



Attention

Follow the below safety rules for electric connections:

- Disconnect all the intense current and controllable current connections.
- Hang the warning sign and lock up the security lock to make sure the system will not be accidentally operated.
- Use the insulating materials to cover the live parts.
- Setup the ground connection and protective short-circuit connection.
- Ensure the DC/BUS, AC BUS, and high voltage capacitors are not electrified using the universal meter.

2.4 Installation Tools

Required tools for installation:

No.	Name	Specification	Description
1	Diagonal plier	-	To cut the wire tie
2	Wire stripper	-	To peel the wire skin
3	Wire cutter	-	To cut the wire
4	Wire crimper	-	To hold the wire
5	Universal meter	-	To test the ground connection
6	Measuring tape	-	To measure the diameter
7	Level ruler	-	To make sure the equipment placed horizontally
8	Safety gloves	-	Protect the workers hand from installation
9	Insulating gloves	-	Prevent the eclectic short.

Notes: The installation tools are not limited to the list above. Please prepare the tools based on site conditions.

Operation

CE-6000A EV Battery Test System



Attention

If you are a first-time user, please read the manual from Chapter 3. Even if you are an experienced user, please carefully read ‘Safety Precautions’ in Chapter 3 too.

Chapter 3. Safety Notice

This chapter introduced the security precautions that must be observed when using the equipment. Before operating this equipment, please read this chapter carefully, comply with it to ensure the operator's safety, and prevent damage to the test samples or devices.

3.1 Safety Precautions

- Arrange for a certified electrician to check whether the equipment is properly installed and meets grounding requirements.
- Only qualified technicians with relevant training experience should maintain or repair this battery testing equipment.
- Use appropriate safety guards, procedures, and battery testing inspection equipment.
- Do not operate the equipment in a humid condition.
- If the humid working conditions are unavoidable, please ensure the operating technician is standing on dry rubber mats or dry wood, insulation material for protection is required.
- Ensure the operating technician wears gloves, and never operate alone.
- The installation and maintenance of the equipment must comply with the local applicable laws and regulations.
- Regularly check the insulation and interface wear pattern. Promptly replace any cracked or frayed cables.
- Never overload the cable.

The safety warnings listed in this manual only represent the parts that Neware realized. Neware does not take any responsibility for losses due to violations of the general safety operation requirements or violations of the safety standards for the design, production and usage of test equipment.

3.2 Operating requirements for technician

Only certified technicians are qualified for operational practice such as transportation and installation.

- Before the operation, remove conductive objects such as jewelry and watches to avoid electric shock or burns.
- Please wear insulated gloves and shoes before the operation.
- Please understand the proper operation method before using the tools, in case of injury to someone or damage to the equipment.
- When this test equipment is operating in a humid environment. When this test equipment is operating in a humid environment, turn off the power as soon as you realize any water or moisture in the cabinet.

3.3 Label Requirements

- The warning sign on the tester and cabinet contains important operation information, and the warning sign is not allowed to be torn or damaged.
- On the inner side of the front door and the surface of the rear cab are labeled with a nameplate, which contains information about this equipment. The nameplate is not allowed to be torn or damaged.

3.4 Safety Warning Requirements

To prevent faulty operation of irrelevant workers or any accident during the installation, regular maintenance and inspection, please follow the rules below:

- Set up a visible sign on the front and rear switches of the equipment, to prevent accidents caused by incorrectly closing the switch.
- Set up a warning signboard or safety warning type near the installation area.
- After the installation, be sure to lock the cabinet door and keep the keys safely.

3.5 Fire Escape Requirements

To ensure that staff can evacuate the site quickly in the event of an accident, please follow the rules below:

- Two tunnel escape doors should be reserved for the risk of fire hazard.
- During the whole process of tester installation and other operations, it is necessary to keep the tunnel escape open.
- Do not store any sundries in the tunnel escape, or occupy the tunnel escape.

3.6 Installation Requirements

To avoid the noise generated during the operation of the equipment and other possible emergencies affecting the nearby resident's normal life or causing safety accidents, the equipment must be installed in the electrical control room.

- The operating control room should be away from the resident areas and be suitable soundproofed.
- It is prohibited to pile up any combustible materials in and around the control room to prevent fire hazard.
- The design of the operating control room should meet the requirements of the equipment ventilation and heat dissipation, as well as the safe escape of personnel.
- The operating control room should comply with relevant EMC design standards.

3.7 Electrical Connection Requirements

Ensure that electrical connections are executed in accordance with the instructions in this manual and electrical connection principles.

The current, voltage, and power parameters must meet the technical requirements of this equipment.

Grounding Requirements

- For electrical connection, the protective earth wire must be installed in advance; when dismantling the equipment, the protective earth wire must be removed at the end.
- Before operating the tester, ensure that it has been installed with a reliable grounding; poor grounding of the equipment may result in personal injury.
- Do not operate the equipment without the grounding conductor installed.

AC/DC operating requirements

- Due to the high voltage of power supply, physical or humid contact is not allowed.
- Irregular or incorrect operation may cause fire or electric shock.
- The forestage protection switch of the tester must be turned off before practicing electrical connection.
- Ensure that the electrical connection to the equipment must have been made before switching on the power.

Anti-static requirements

- Before contacting the circuit board, you must wear ESD gloves or ESD wrist straps, and the other end of the wrist strap must be well grounded.
- When holding the single board, the edge of the single board must be free of components, and it is not allowed to touch the chip with your hand.
- The disassembled single board must be packaged, stored or translated with anti-static packaging materials.

3.8 Power-off Operation Requirements

Make sure that the test equipment is completely uncharged before performing power-off operations.

- Ensure that the device is not accidentally re-powered.
- Use the universal meter to ensure that the inside of the tester is completely uncharged.
- Cover the live parts with insulation material.
- Grounding and short-circuit connections are required.
- Make sure the emergency exit is unblocked during the entire operation.
- After the device is completely out of operation, be sure to wait at least 5 minutes to ensure that the internal capacitance is completely discharged before operating the machine.

3.9 Scrap Requirements

The tester can not be treated as regular waste when it needs to be discarded. To prevent pollution to the environment. Please contact your local authorized professional recycling agency to prevent pollution of the environment.

3.10 Other Protection Requirements

When transporting and installing the test equipment, all appropriate protective measures should be taken, such as wearing ear plugs, insulated shoes and anti-scald gloves, etc.

If any injury occur, please contact the local emergency centre.

Chapter 4 .Equipment Introduction

This chapter is introduces the system composition, topological structure, technical norm, operational principle and other related contents of the equipment.

4.1 System Composition

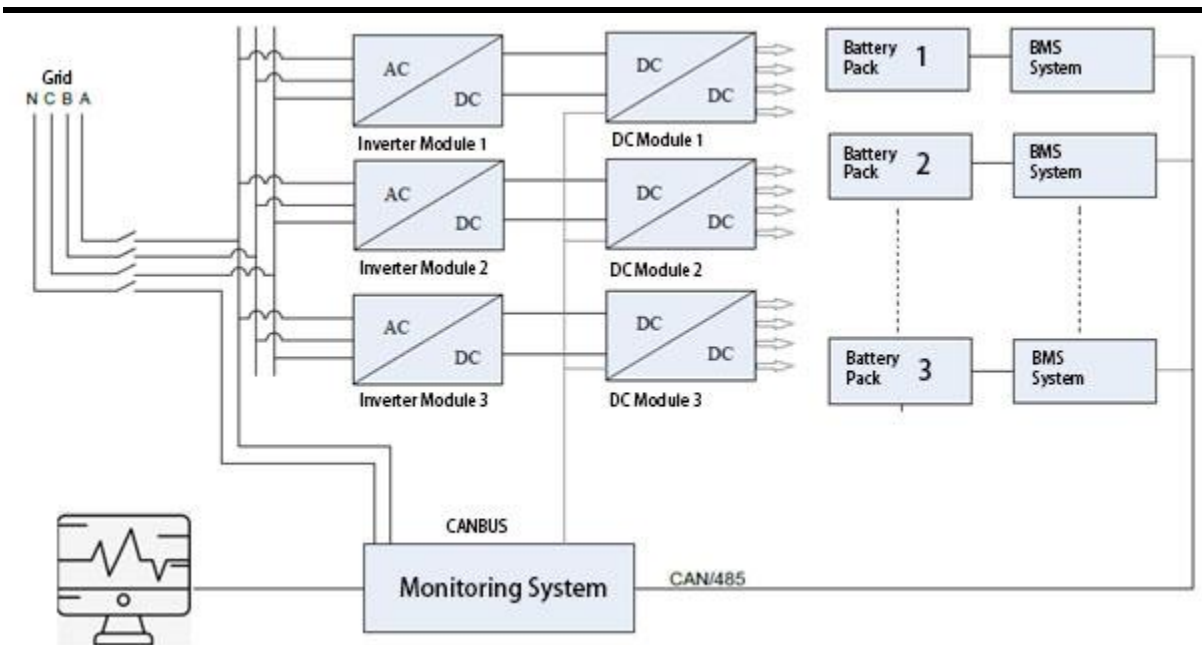

According to the chart, The battery testing system is mainly composed of AC distribution, power module, and monitoring system. The power module includes bidirectional inverter module, which can realize AC/DC or DC/AC conversion.

The DC/DC module can control the charge and discharge of batteries of different voltage levels, and realize the bidirectional conversion of the DC part. When charging, it will convert the DC bus voltage output by the AC/DC module to the charging voltage that is to be set. When discharging, the battery voltage is converted into bus voltage, which is provided to the AC/DC module and fed back to the power grid.

The monitoring system can realize remote control of the host computer through Ethernet, including constant voltage charge and discharge, constant current charge and discharge, constant power charge and discharge, pulse and driving simulation test. Channel parallel operation can also be realized according to requirements.

4.2 System Topology

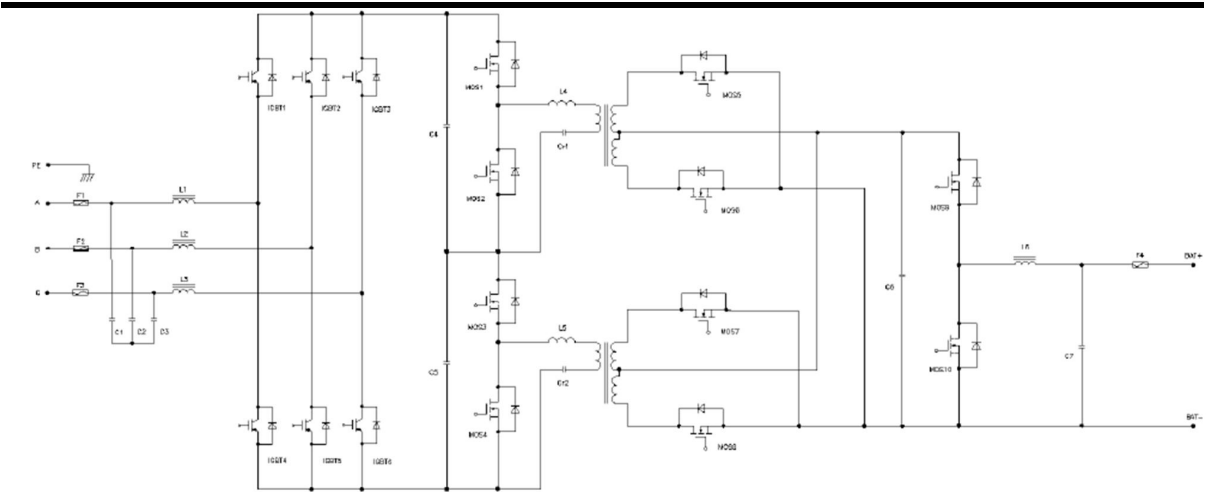

The figure above shows the network topology of CE-6000n tester. This system is composed of input circuit breaker, bidirectional converter module(AC to DC), bidirectional DC module(DC to DC), which can provide a maximum of 12 batteries to work at the same time. The AC to DC bidirectional converter module is composed of input protection, EMI filter, three-phase H-bridge PFC, LLC soft switching, three-phase parallel rectifiers in parallel, output filter. The bidirectional DC module is composed of input protection, BUCK-BOOST DC converter, output filter and output relay.

4.3 Specification

CE-6000 Specification		
Model		
Material code	CE-6016A-5V300A-H	
Channels information		
Channels quantity	Channels quantity in one unit	16
Main channel	Channel features	Constant current & voltage source Dual closed loop control
	Channel control mode	Independent control
	Channel parallel connection	Support Max 4 channels parallel mode, without pulse and simulation test after parallel
Power grid side parameters		
Input power		AC380V ± 15% 50/60 ± 5Hz
Power factor		≥99% (fully loaded)
THDi		≤5% (fully loaded)
Input impedance		≥1MΩ
Input power		34.3KW
Input current		52.1A/Phase
Overall system efficiency(Max)		75%
Noise		≤65dB
Voltage&Current sampling		Four-wire connection(same port for charging and discharging)
Power control module type		MOSFET
Input power wiring method		Three-phase-five wire
Safeguard		Anti-surge, anti-silos, anti over or under frequency, anti over or under voltage, anti phase absence, etc.

Functions and performances		
Voltage	Output range	Charge:0V~5V Discharge:1.5V~5V
	Min discharge voltage	1.5V
	Accuracy	±0.05% of FS
	Resolution	24bit
	Current	Range1:0.375A~75A Range2:75A~150A Range3: 150A~300A
Current	Accuracy (independent range)	±0.05% of FS
	CV cut-off current	Range1: 75mA Range2: 150mA Range 3: 300mA
	Resolution	24bit
	Power	Single channel output power 1.5KW Whole machine output power 24KW
Time	Current response time	≤3ms
	Current conversion time	≤6ms
	Min. step time	0.1s
Charge/Discharge modes	Charge modes	CC, CV ,CCCV, CP CC,CV,CP,CR
	Cut-off condition	Voltage, Current, Δ Time, Capacity, -ΔV
	Simulation	Charge Current, Power Discharge Current, Power Switch Support the continuous switching between charge and discharge Cut-off condition Time, Step line Step file lines 1,000,000
Pulse Mode	Charge	Current, Power
	Discharge	Current, Power
	Min pulse width	100ms
	Pulses counts	Up to 32

	Charge and Discharge switch	Supported
	Cut-off condition	Voltage, Time
DCIR		DCIR by automatic calculation
Safety protection	Software	Power-off data protection
		Off-line mode available
	Safety protection conditions can be set, the parameters including voltage lower limit, voltage upper limit, current lower limit, current upper limit, delay time, etc.	
Hardware	Anti-reverse connection, over-voltage/current/temperature,etc.	
Data management and analysis		
Step setting method		Form editing
Data report	Recording conditions	Min data record interval: 10ms
		Min voltage interval: 0.01V
		Min current interval: 0.15A
	Recording frequency	100Hz
Database		MySQL database
Data Export		Excel、Txt
Curve type		Templates available, customization supported
Bar-code scan		Support bar code scanning function
		Management and traceability of historical data
Communication		
Host computer communication		TCP/IP protocol
Communication port		Ethernet
Communication baud rate of the testers		1M
Host computer baud rate of the testers		10M~100M adaptive
Communication setup		Set up a LAN(local area network) through switches and routers
Communication extension(optional)		Support CAN, RS485 communication and BMS communication,with DBC configuration function

Environmental requirements, dimension and weight		
Operation environment temperature		-10°C~40°C (guaranteed measurement accuracy within 25 ± 10°C; precision drift 0.005% of FS /°C)
Storage environment temperature		-20°C~50°C
Operation environment humidity		≤70% RH (no condensation)
Storage environment humidity		≤80% RH (no condensation)
Dimension W*D*H		600*660*1850(mm)
Weight		306KG
Tester Appearance(for reference only)		
Auxiliary test system(optional)		
Temperature aux channels	Temperature aux channels	Thermistor: -30°C~120°C
		Thermocouple: -200°C~260°C

	Temperature accuracy	±1°C(with 2meters cable length)
	Temperature resolution	0.1°C
Voltage auxiliary channels	Voltage range	0V~5V
	Voltage accuracy	±0.05% of FS
	Voltage resolution	0.1mV
Aux Introduction	It is mainly used to monitor the temperature of the battery surface or the tabs during the test. The aux test data can be bound with the main voltage and current data, along with high precision. At the same time, the measured temperature can be used as the control condition and protection condition of the test profiles.	

Chapter 5 .Touch Screen Description



This chapter is introduce the information and operation method about the touch screen controller. CE6000A series equipment is loaded with 7”capacitive color touch screen, which is easy to operate. Users can quickly check the running information,and practice the relevant setting. The following chapters will introduce the content of the controller’s interface.

5.1 Home page

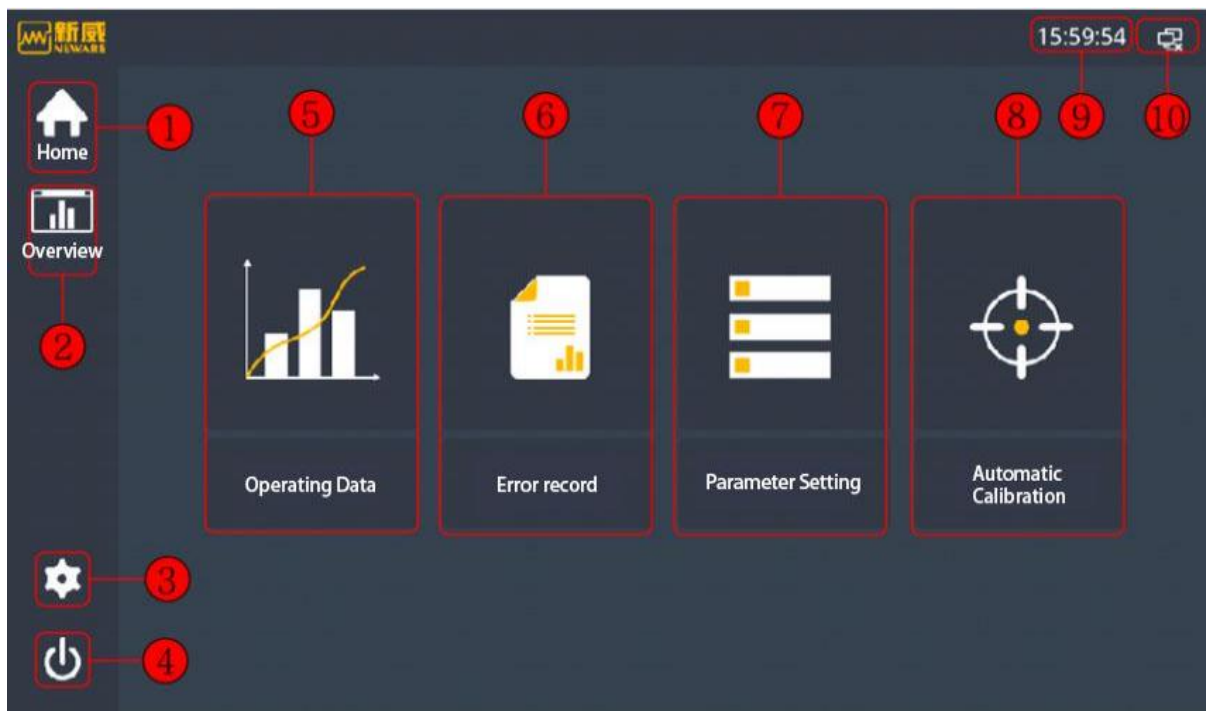
This interface is designed for menu selection. In this interface, the user can choose to enter the operating data, fault records, parameter settings, automatic calibration, overview, settings, switcher(Switch machine) and other interfaces. The upper left of the interface displays the current time and communication connection status.



Here is the introduction of the touch screen homepage:

No.	Items	Description
1	Home page	Button to enter the home page
2	Overview	Button to enter the overview interface
3	Setting	Button to enter the setting interface
4	Switcher	Button to enter the switcher interface
5	Operating data	Button to enter the operating data interface
6	Fault/Error record	Button to enter the fault/error record interface
7	Parameter setting	Button to enter the parameter setting interface, after-sales personnel can enter the password only
8	Automatic calibration	Button to enter the auto-calibration interface
9	Current time	Display of local time
10	Communication status	Display of communication status,  : Normal,  : Abnormal.



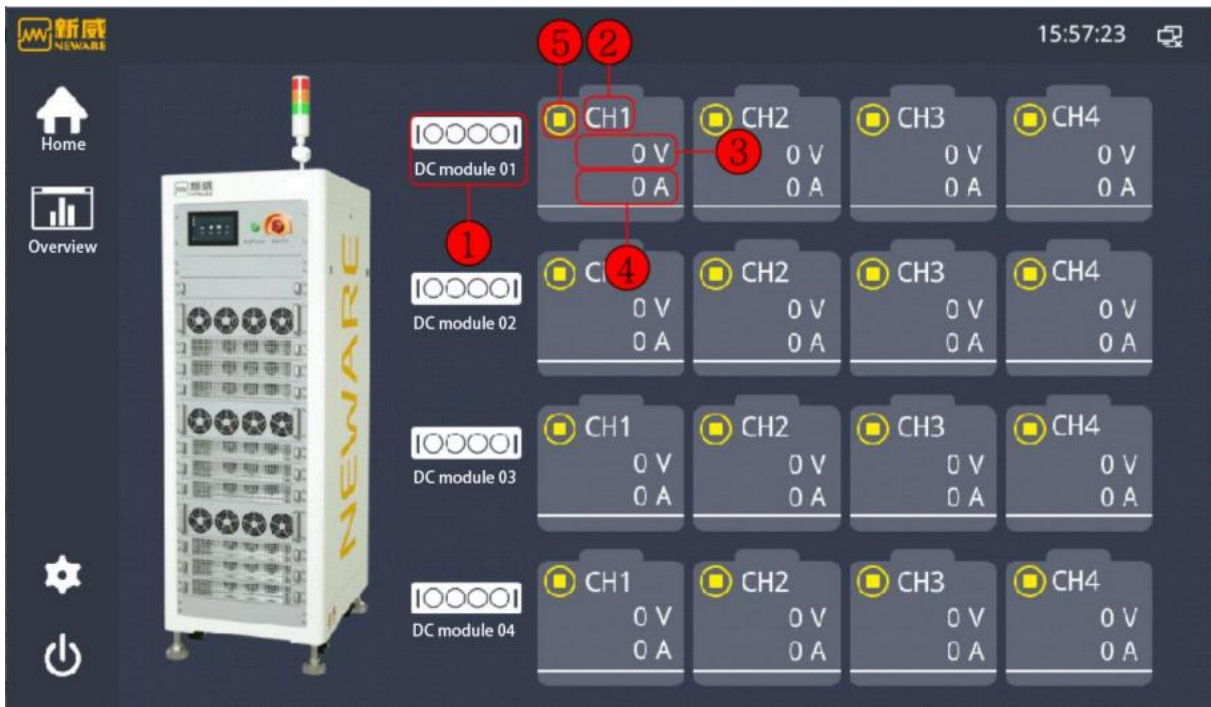

5.2 Overview

After the system is initialized, enter the overview interface where you can view the operating status, voltage and current of all physical channels, and the user can enter the home page, settings, switcher, operating data and other interfaces. The upper left of the interface displays the local time and communication connection status and other relevant information.



Attention: this information displayed is physical channel information, the client software for the actual channel information

Description of the overview interface:

No.	Items	Description
1	Operating data	Click this button to jump to running data interface for relevant module
2	Physical channel quantity	4 physical channels, 2 negative pressure module physical channels
3	Voltage	Display the voltage value of the current channel
4	Current	Display the current value of the current channel
5	Operating status	Display the operating status of the current channel  : Pause,  : Reset,  : Charge,  : Discharge,  : Fault

5.3 Setting

This interface is for the setting of the touch screen, you can enter home page,overview and switch machines through this interface. The upper left of the interface displays the local time and communication connection status. Also, you can set the date and time, calibration period, display and brightness, language right here.

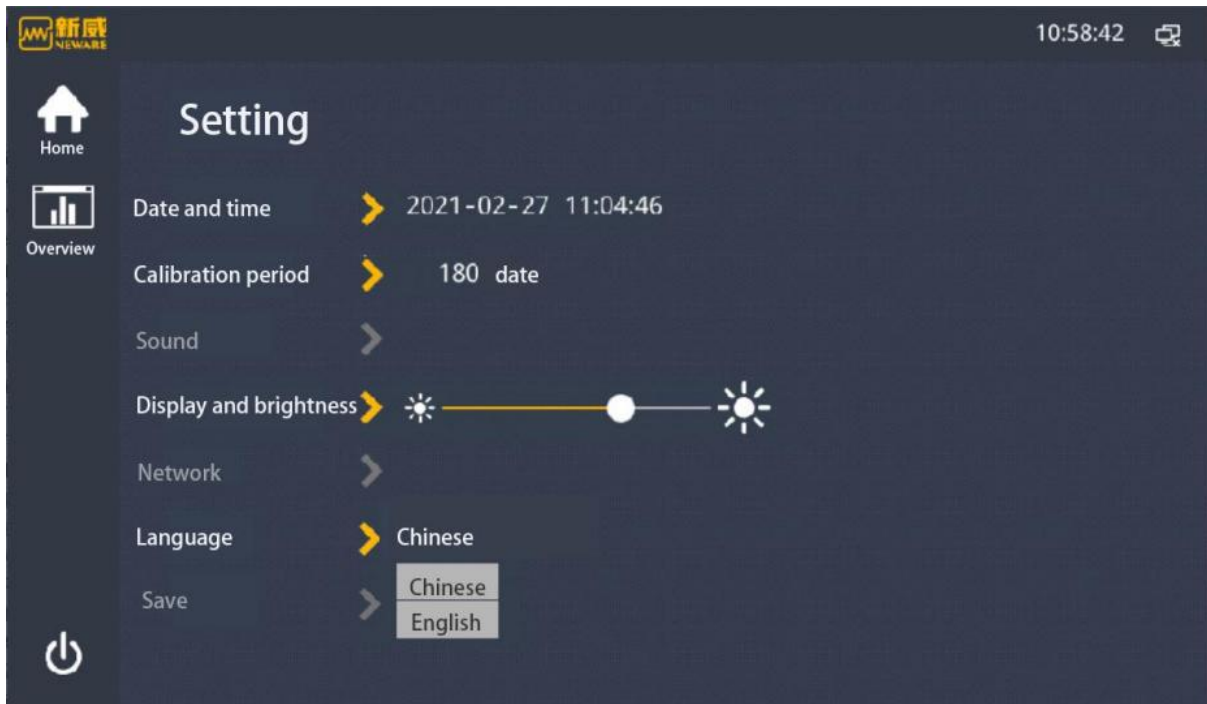

Description of the setting interface:

No.	Items	Description
1	Date and time	For time setting
2	Calibration period	This is for calibration reminder. When the time reaches the assigned time, the touch screen will pop up the calibration reminder interface.
3	Display and brightness	Brightness of the touch screen
4	Language	Support Chinese and English interfaces

5.4 Switch machine

The interface of switch, home page, overview, settings and other interfaces are available in this interface. The upper left of the interface displays the local time and communication connection status and other information. Also, operation of module switch and channel switch are available.

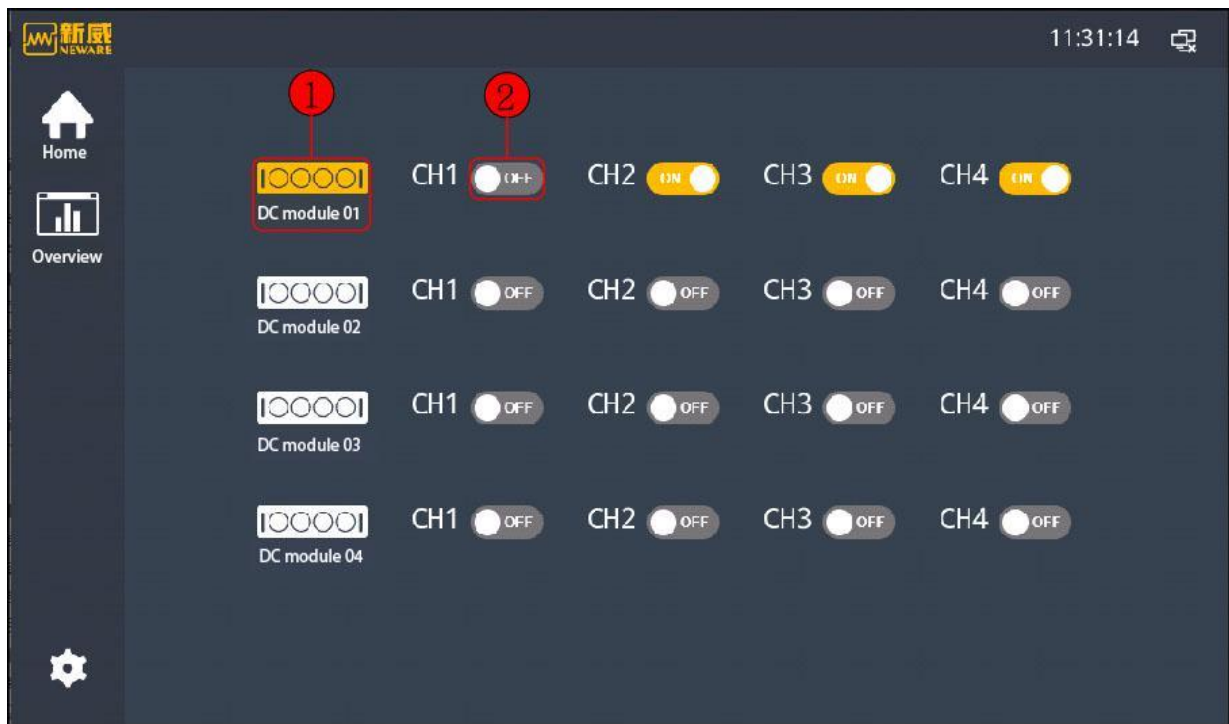

Description of switch machine interface:

No.	Items	Description
1	Module switch	Click this button (gray: turn off, yellow: turn on) for turning on/off the current module. The channel switch button works only when the button is on power.
2	Channel switch	Click this button (gray: off, yellow: on) to perform the on/off operation of the current channel.

5.5 Operating data

This interface displays operating data information of the module. You can enter the home page, overview, settings, power on and off, fault record and other interfaces through this interface. The upper left of the interface displays the local time and communication connection status and other information.



Description of the operating data interface:

No.	Items	Description
1	Next page	Click this button to enter the fault record interface
2	Switch to the previous module	Click this button to enter the operating data interface the previous module.
3	Switch to next module	Click this button to enter to the operating data interface of the next module.

5.6 Fault record

This interface is for the fault record. You can enter the home page, overview, setting, power on/off, operating data, parameter setting and other interfaces through this interface. The upper left of the interface displays the local time, communication connection status and the other information. This interface will statistics the fault information of all modules, including fault description and fault sending time, and these information will be stored.

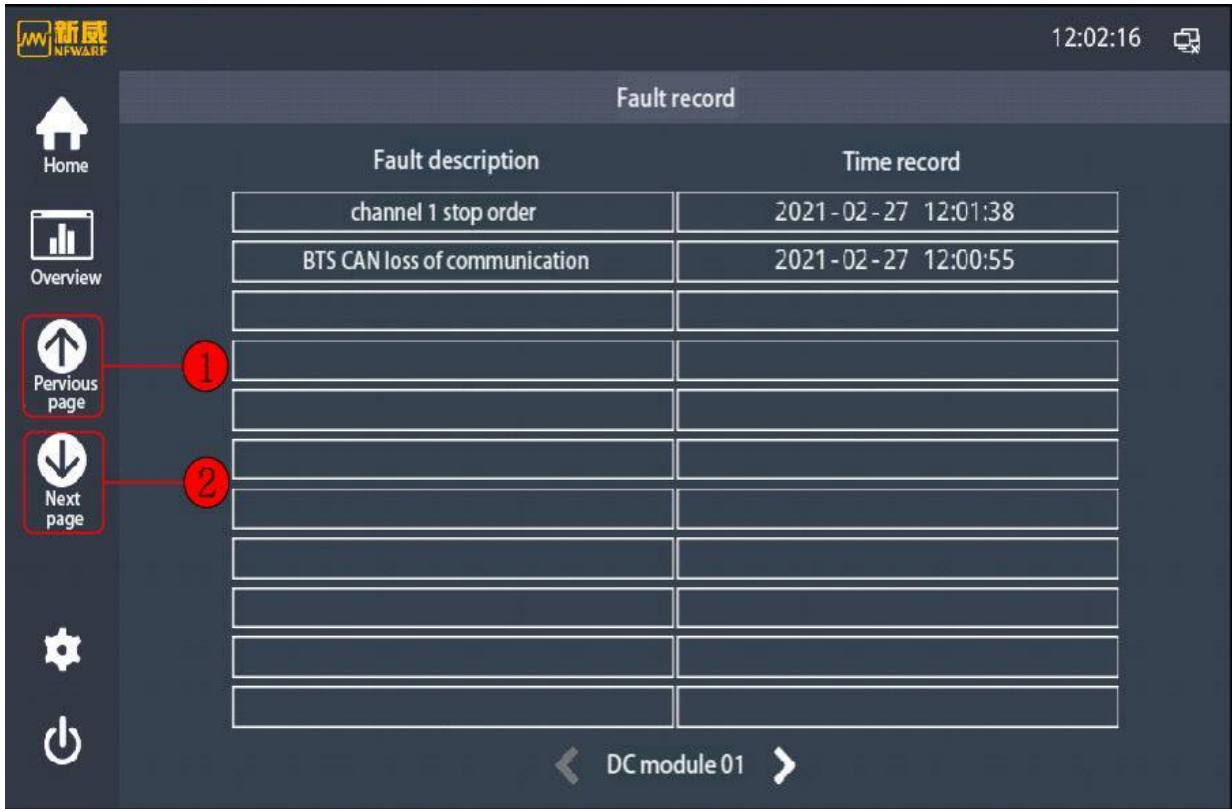

Description of the fault record interface:

No.	Items	Description
1	Previous page	Click this button to enter the operating data interface
2	Next page	Click this button to enter the parameter setting interface (password required).

5.7 Automatic calibration

This interface is for automatic calibration .This is required for pairing with automatic calibration tools. Through this interface, you can enter the home page, overview, settings, power on/off, parameter setting, and other interfaces. The upper left of the interface displays the current time, communication connection status and other information.

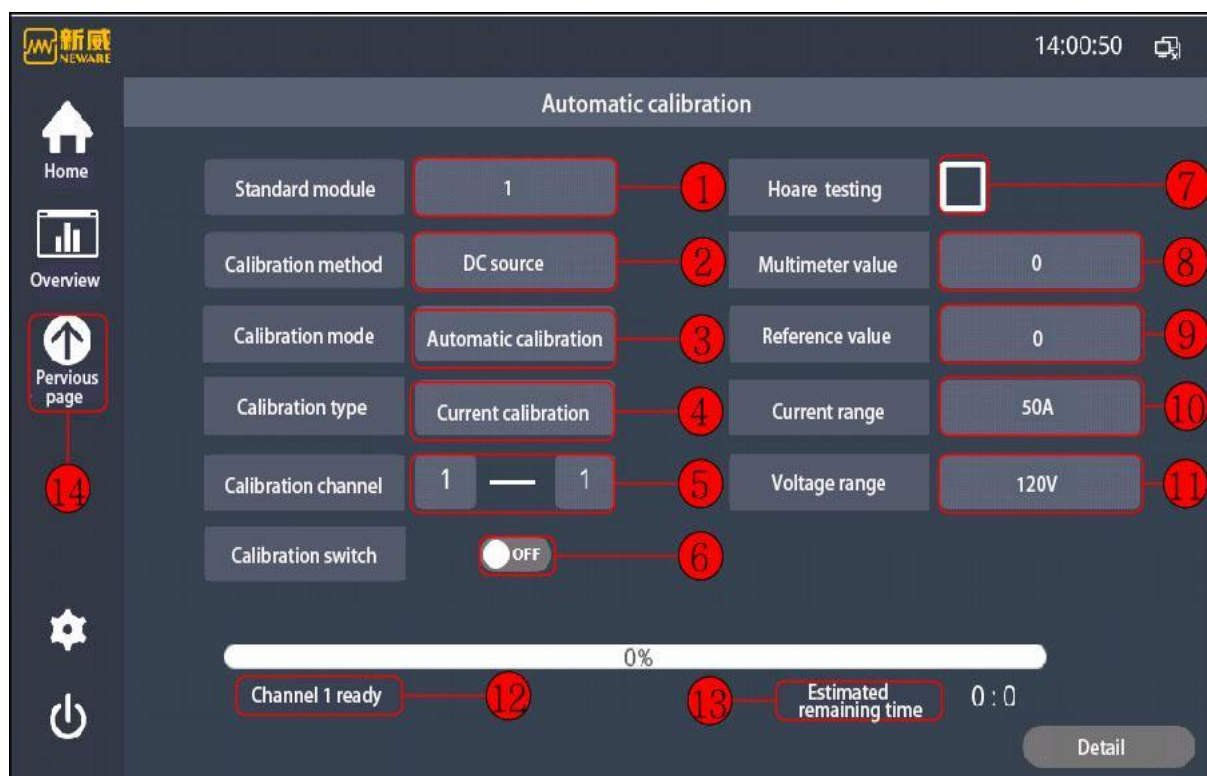

Description of the automatic calibration interface:

No.	Items	Description
1	Calibration module ID	To set the ID of current calibration module, the default ID is 1
2	Calibration method	DC source/battery, automatic calibration to select "DC source"
3	Calibration mode	Automatic calibration/manual calibration/precision test Select "automatic calibration" from the auto-calibration tool After calibration, you can select "precision test" to check the accuracy of the calibrated module
4	Calibration	Current calibration/current calibration/voltage calibration, select the type to be calibrated based on your needs. When the calibration is in "accuracy test" mode, only "current calibration" or "voltage calibration" are available
5	Calibration channel	Start channel—end channel, begin channel value<end channel value
6	Calibration switch	Start or stop the calibration operation.
7	Hall measurement	After clicking the check box, if the current accuracy of the calibration channel exceeds 0.05%F.S., "Accuracy out of range" will be prompted and the calibration will be stopped
8	Universal-meter	Display the current external value during "manual calibration" or "accuracy test"
9	Reference	In the "Accuracy Test" mode, it is use to input the reference set value
10	Current range	Select the corresponding current range according to the voltage level of the equipment model

11	Voltage range	Select the corresponding voltage range according to the current level of the equipment model.
12	Prompt information	Display the status and fault information of the current stage in the "auto-calibration" mode.
13	Estimated remaining time	Display the remaining time of calibration in a countdown mode
14	Previous page	Click this button to enter the parameter setting interface (password required).

Chapter 6.Operation

This chapter describes the pretest preparation and inspection, methods of start the test, end the test. Please follow the method below for every test.

6.1 Power on

- All installations and connections are secured according to the user manual and circuit diagrams.
- The EMERGENCY STOP button has been loosened, and the manual ON/OFF switch is in the "OFF" position.
- Use the instrument to test whether the AC and DC side voltage meets the equipment startup conditions, and whether there is no danger of over-voltage.
- If you are doing a restart practice after a fault, make sure the error is completely eliminated.
- Turn the manual switch to "ON" - equipment running - start self-inspection-equipment will run automatically after self-inspection.

6.2 Power off

This type of equipment has the following two shutdown modes:

- Quick shutdown (using the EMERGENCY STOP emergency shutdown button or ON/OFF manual switch), but only in emergency or fault cases.
- Controlled shutdown, using touch screen control shutdown, used under normal circumstances

 **Warning**

- **To open the cabinet door and operate in the cabinet, be sure to wait at least 5 minutes after shutdown and test with a universal-meter and other instruments to ensure safety!After turning off, the DC input and AC output are still charged and do not touch.**
- **After turning off, the DC input and AC output are still charged and do not touch.**
- **Only qualified and trained operators can operate the converter.**

Chapter 7. Maintenance

This chapter describes the inspection and maintenance of the testing equipment.

To maintain the inspection equipment in a good working condition, regular inspection and maintenance are required. Regular inspections can prevent the problem from the beginning, and keep the equipment in an optimal (and therefore safest) working condition.

7.1 Relevant matters

Keep in mind the following rule for all the maintenance and inspection:

- Disconnect all internal and external strong/control power connections to the equipment.
- Label the warning signs and lockup the safety locks to ensure that the equipment is not accidentally operate.
- Cover and isolate the possible live parts with insulating cloth or partition plate.
- Install ground connection and short-circuit protection connections.
- Use the universal-meter to ensure that the equipment DC bus, AC bus, high voltage capacitance are uncharged.

7.2 Inspection and maintenance

If the following inspection results any abnormal sign, please contact our after-sales service representative.

Content	Methods	Period
Cabinet inspection	<ul style="list-style-type: none"> ● Check the appearance of the equipment for damage, deformation, or dirt. ● Check whether the door hinge is over-tighten (hard to open), if so, spray the door hinge with high quality silicone oil lubrication. 	Once a year
Grounding reliability	Check whether the protection grounding and power input grounding works properly	Once a year
Distribution reliability	Action test of main power switch (leakage circuit breaker)	Once a month
Operating status of equipment	<ul style="list-style-type: none"> ● Check whether all equipment in the equipment are functioning properly. ● Check whether the lighting protector works properly. 	Every 6 month
Electrical connection	<ul style="list-style-type: none"> ● Check whether cables are well-connected ● Check whether the cable is damaged (check for any cutting mark on the cable skin). 	Once a year
Fan check	Inspect and clean the fan regularly. If fan fails occur, repair or replace it on time to ensure proper ventilation	Every 6 month

7.3 Clean Maintenance

To clean the dust inside the equipment, blow low-pressure compressed air into the equipment from the bottom and then blow low-pressure compressed air into the top of the equipment.

Chapter 8 .Repairing

Troubleshooting of possible equipment failures.

8.1 Recovering of fault operation



Danger

Be careful of electric shock! Disconnect the power supply before inspecting the power circuit.

Turn off the external power supply switch before removing the cover plate of power distribution cabinet.(The power cord may unroll if the cover is accidentally dropped.).

When a fault is detected, a corresponding fault sign will appear on the control panel or display screen. The maintenance technician can locate the possible causes of the fault based on the fault information.

When the fault occurs

Practice the following steps to rectify the fault and restore the equipment. If the fault cannot be resolved, contact the equipment technician for maintenance.

1. If the equipment is running, shut it down and make sure that the equipment is not running.
2. Turn off the main power switch (leakage circuit breaker).
3. According to the alarm prompt to practice troubleshooting.
4. Close the power supply switch (leakage circuit breaker).

8.2 Common faults

Even small omissions, rather than failures of the device itself, can cause the device to fail, so it is recommended to review the following table carefully, as it summarizes the information that can help resolve the most common problems.

Issues	Possible causes	Solutions
The power indicator is off	The municipal power input line is disconnected	Check weather the input cable is correctly connected
	Trigger of superior leakage protection switch	Reset the protection switch Note: make sure if other branch equipment causes switch overload
	Input breaker is off	Turn on the equipment's input breaker
Poor communication	The communication cable is over-length	Connect the functional communication cable to the abnormal equipment, and use the software to see if the equipment connection is functional (pay attention to the serial port settings).
	Aging of the communication cable	
	Computer serial port card is unstable	
	Software Setup Error	Check the software setting
Equipment has no charge or discharge current with the indicator light on	The equipment is resting	Check the software settings and confirm that the step is setting correctly
	The voltage sampling cable is disconnected	Verify if the voltage sampling cable is properly connected
	Output cable is disconnected	Verify that the battery cable is properly connected
	Reverse connection of output cable	Check that the cathode and anode of the battery cable are properly connected

Chapter 9 .Warranty

The warranty period of this product is subject to the contract. If the product fails during the warranty period, the Company will repair or replace the product with a new one free of charge.

If the product is to be repaired or replaced during the warranty period, the Company requires the customer to present the invoice for the purchase of the product. At the same time, the trademark on the product should be clearly recognizable, otherwise the Company reserves the right not to give quality assurance.

Neware has the right not to execute the warranty under the following situations:

1. Damage from transportation.
2. Incorrect installation, modification, abuse.
3. Operates in a harsh environment.
4. Damage caused by natural disasters.
5. Machine failure that are not caused by Neware's employees.
6. Machine failures or damage that is not caused by Neware's components or software.
7. Any installation and usage that is not specified in relevant international standards.

If customer requires maintenance service due to the above situation, the maintenance services with service fee is available.

Service Record

Product		Modle		Serial number	
Date	Content		Maintenanc e technician	Customer representative	Note